



EL-EJB-S001

Solar Junction Box

SPECIFICATIONS

Description	Solar Junction Box 3in / 4in
Certificate	UL

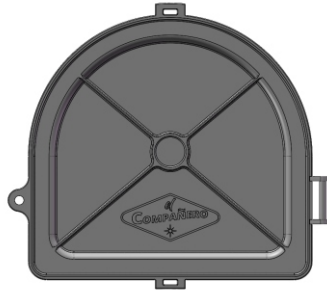

Size

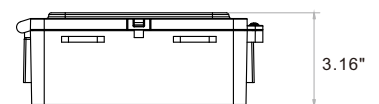
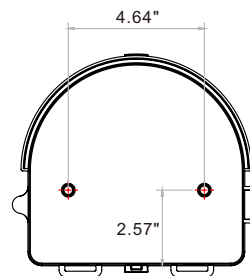
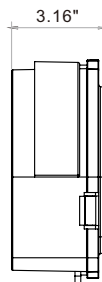
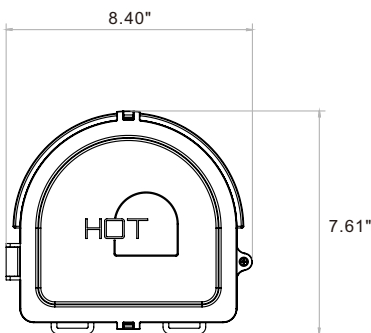
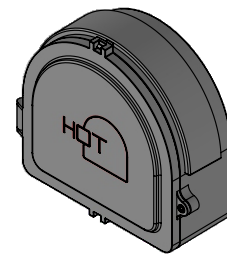
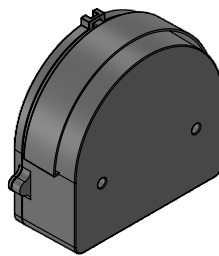
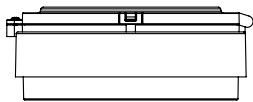



EL-EJB-S001 Solar Junction Box

Size

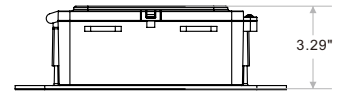
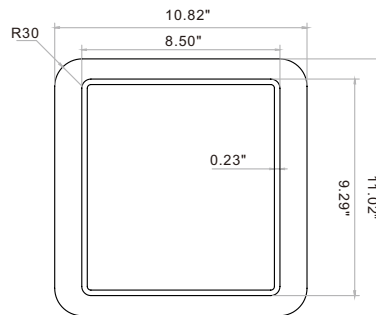
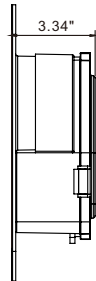
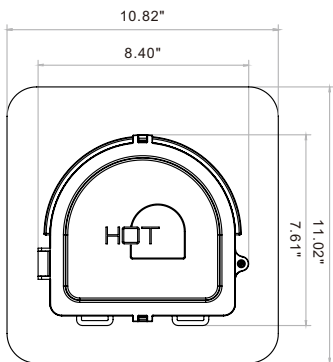
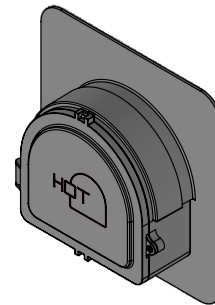
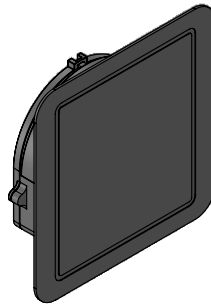
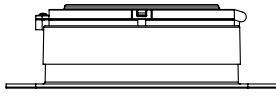

Internal Diagram

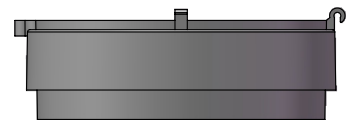
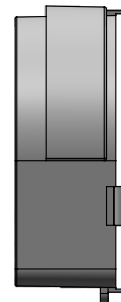
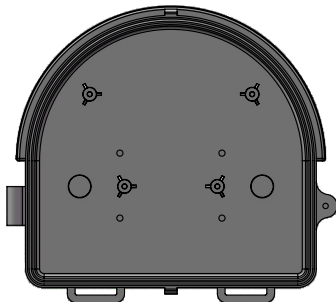
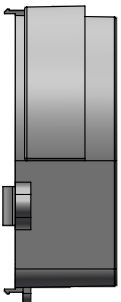
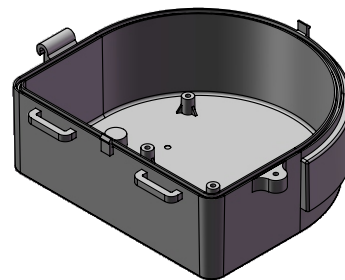
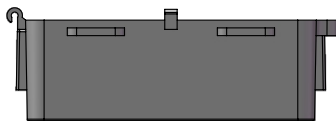



EL-EJB-S001

Solar Junction Box

Part Specification

Description	Lid Screw
Size	PA0.15" x 0.62"
QTY	2 PCS



Part Specification

Description	Zip Tie
Size	6.49" x 0.09"
QTY	4 PCS, 2 x #1.2 x #2



Part Specification

Description	Butyl Tape
Color	Black
Size	0.23"
QTY	1 Set Fitting The Back Panel



Part Specification

Description	Dome Cap
Size	3/4"
Color	Black
QTY	2 PCS





EL-EJB-S001

Solar Junction Box

Part Specification	
Description	Metal Strap
Size	2"
QTY	2 PCS



Part Specification	
Description	Wire Nuts
Size	16 - 6 AWG
QTY	4 PCS



Part Specification	
Description	5 Terminal Ground Bar
Size	1.33" x 1.22" x 0.69"
QTY	1 PC



Part Specification	
Description	Wire Grommet
Size	1"
QTY	2 PCS





EL-EJB-S001

Solar Junction Box

Part Specification

Description	Terminal Block
QTY	4 PCS



Part Specification

Description	Installation Deck Screws
Size	#10 x 1-1/4"
QTY	4 PCS

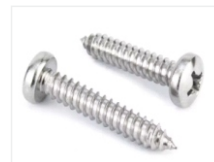

Part Specification

Description	Garbage Bag
Size	23.62" x 35.43"
QTY	1 PC



Part Specification

Description	Stainless Steel Din Rail
Size	4.72" x 1.37" x 0.29"
QTY	1 PC

